



JR Series

Gas Pressure Reducing Valve

GAS PRESSURE REDUCING VALVE

The LowFlow JR Series line of high pressure regulators have the ability to handle very high pressures and very low flows. These valves are typically used in research and sampling systems for general, corrosive and specialty gas and liquid service. Typical applications include gas chromatography and flame ionization detectors, as well as other industrial controls.

Features:

- Top entry design facilitates in-line cleaning and maintenance
- Barstock construction guarantees material integrity and surface finish
- High flow rate coupled with high rangeability reduces need for reduced trim sizes
- Optimized internal volume
- Proprietary Jorlon diaphragm material provides exceptionally long life
- Soft seat material for ANSI Class VI shutoff



A Division of
Jordan Valve
3170 Wasson Road
Cincinnati, OH 45209

toll free. 800.543.7311
local. 513.533.5600
fax. 513.871.0105

www.lowflowvalve.com

JR SERIES SPECIFICATIONS

Line Size: 1/4", 3/8", 1/2" (DN8, DN10, DN15)

End Connections

- Threaded
- Socket Weld
- Flanged

Soft Seat Materials for ANSI Class VI Shut-off

- PTFE to +150°F (66°C)
- PEEK to +350°F (+177°C)
- Kel-F to +250°F (+121°C)

Body Material

- 316L SST – Standard
- Contact factory for other body/trim/seat materials

Diaphragm Material: Jorlon

Maximum Inlet Pressure*: 4000 psig (276 bar) @ -20°F (-28,9°C)
* ASME B16.34 Design Standards

Pressure at Maximum Temperature: 2550 psi @ 350°F (178,8 bar @ 177°C) with PEEK seat; 3600 psi @ 150°F (248 bar @ 66°C) with PTFE seat

Maximum Pressure Drop: 3000 psi (207 bar)

Internal Volume: 1/4"- 3.1cc , 3/8" and 1/2"- 6.6 cc

Supply Pressure Effect: 0.5/100 psig (0.03/6.89 barg)

Spring Ranges

- 5 – 50 psi (0,3 – 3,4 bar)
- 25 – 100 psi (1,7 – 6,9 bar)
- 50 – 150 psi (3,4 – 10,3 bar)
- 75 – 250 psi (5,2 – 17 bar)
- 100 – 475 psi (7 – 33 bar)
- 200 – 750 psi (14 – 52 bar)

Flow Characteristics

- Cv 0.012
- Cv 0.03
- Cv 0.08
- Cv 0.20

Options

- Panel Mounting
- Captured Vent
- Self Relieving - Available with PTFE seats
- Locking Wire
- Tamper Proof
- Lockout Device

OPTIONS & DEFINITIONS

Panel Mount The panel mount feature utilizes a threaded spring housing and a panel mount ring to secure the regulator to an instrument panel. This option requires a 1-1/2" panel cut out.

Captured Vent The captured vent design provides maximum safety for the user when handling toxic or hazardous media. It features a 1/8" FNPT port located on the spring housing. The user can easily tube this vent to a safe location. This option can be incorporated into a self-relieving regulator that provides an additional port to permit the safe expulsion of hazardous media.

Self Relieving The self relieving option is used for internal venting of downstream pressure. From a practical standpoint, it allows for immediate reduction in pressure setpoints and automatically alleviates regulator lock up.

Locking Wire The locking wire option utilizes a lead sealed metal wire to physically hold the adjusting screw in place to prevent any unwanted set point changes.

Tamper Proof The tamper proof option replaces the standard adjusting knob with a stainless steel acorn nut.

Lockout Device The lockout device is a 2 piece polypropylene enclosure which encapsulates the adjustment knob and prevents unwanted set point changes. The part number required for this valve is 26970. (Lock not included)

JR SERIES FEATURES & BENEFITS

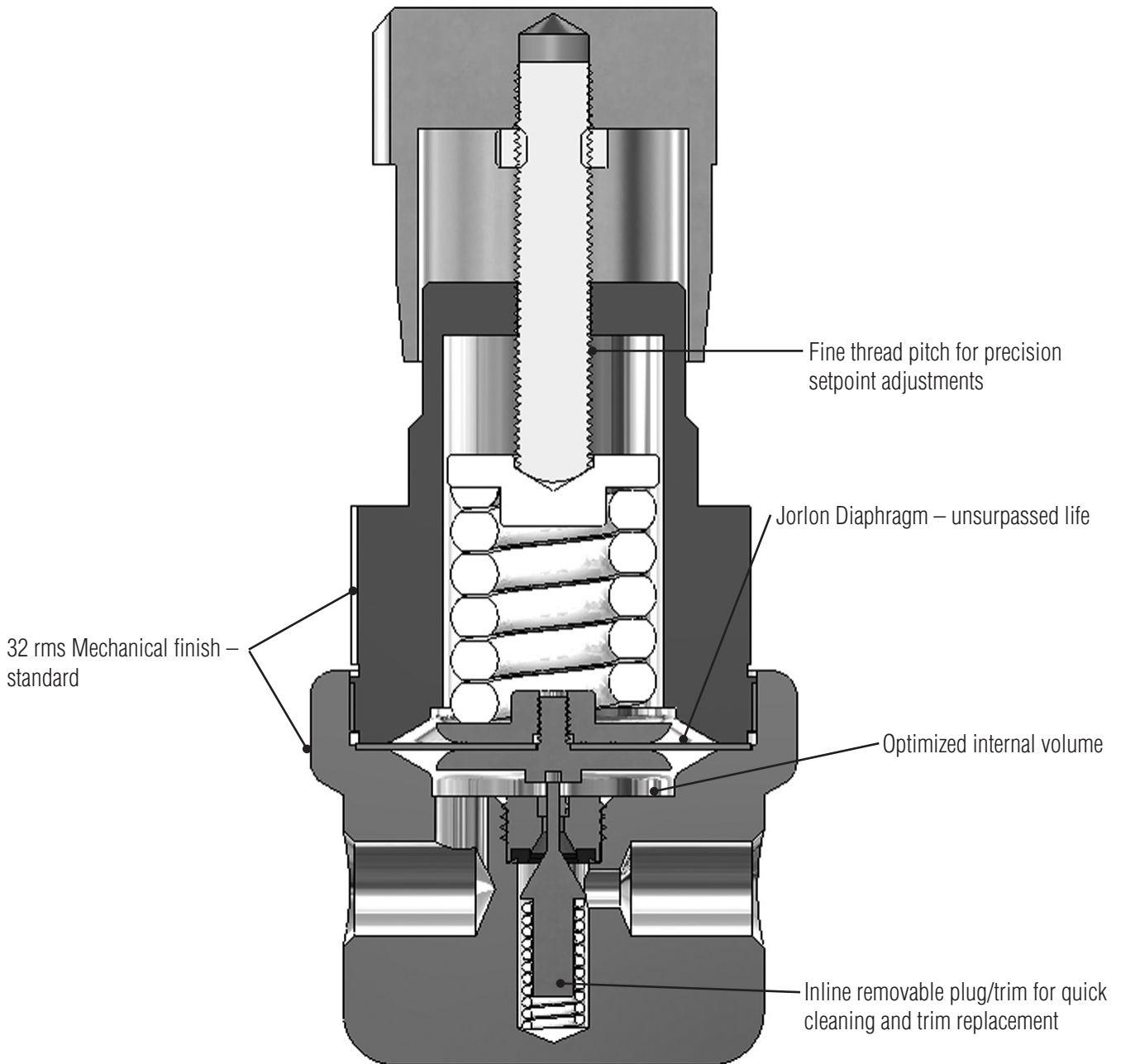

JR SERIES TRIM FLOW GRAPHS

- 0.012Cv – 5 - 50 PSI RANGE

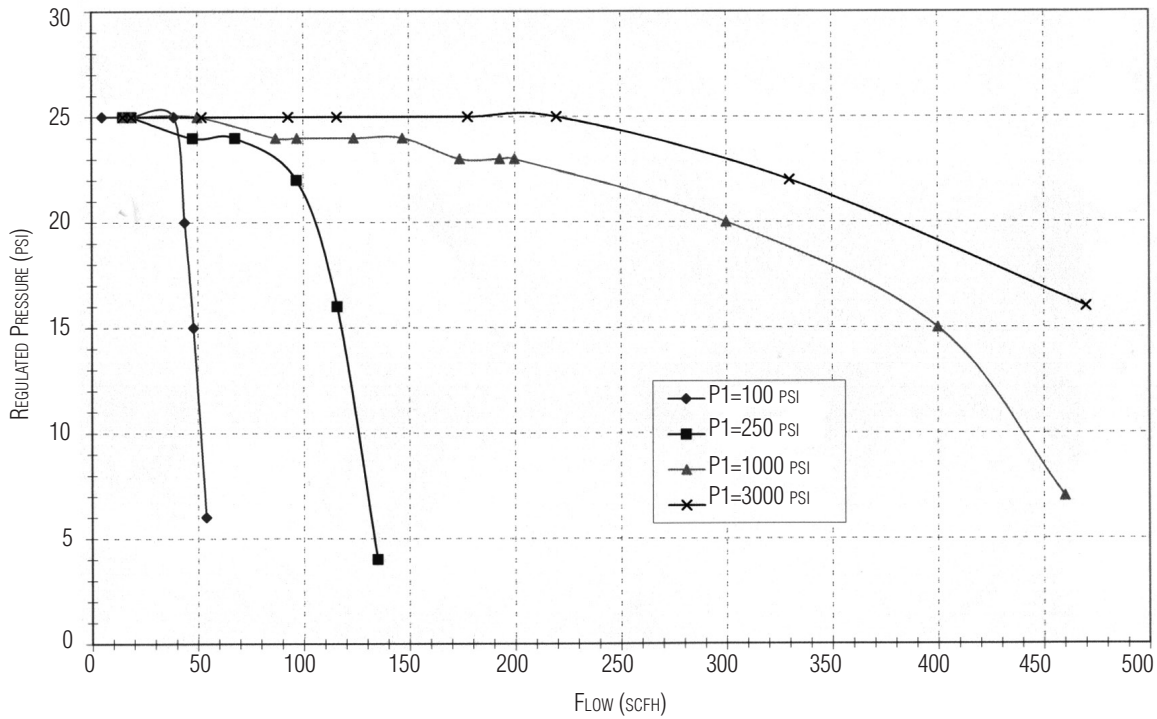

- 0.012Cv – 50 - 150 PSI RANGE

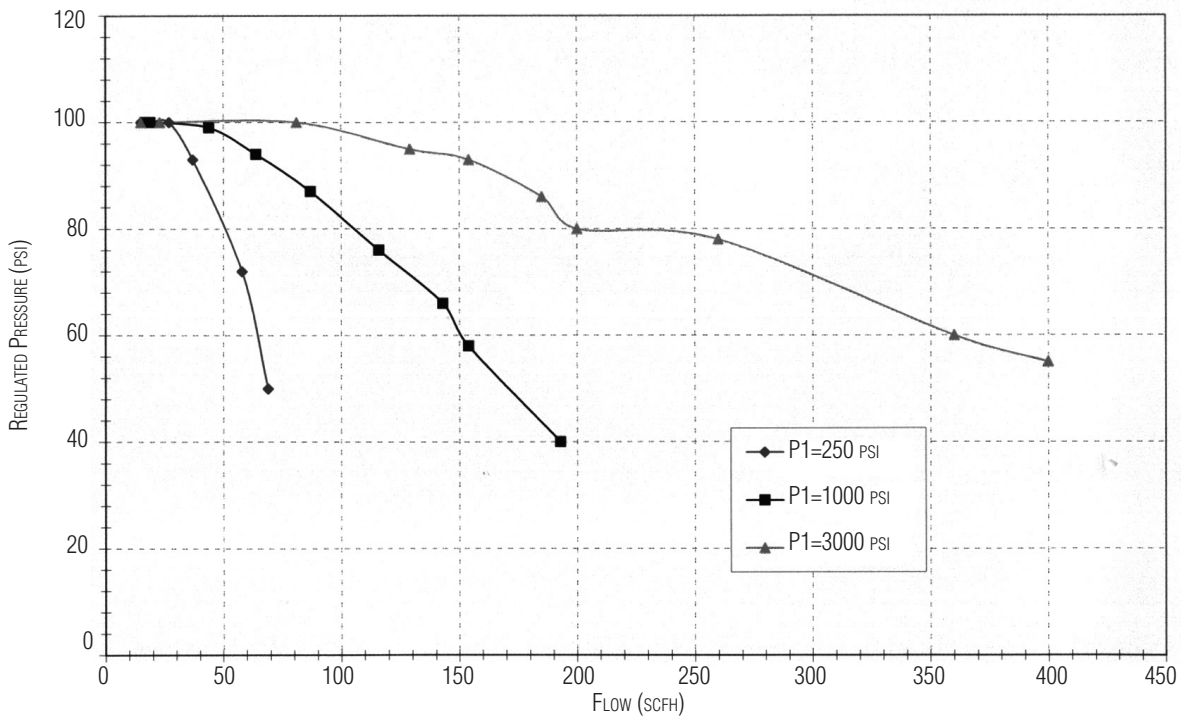

JR SERIES TRIM FLOW GRAPHS

- 0.003 Cv – 5 - 50 PSI RANGE

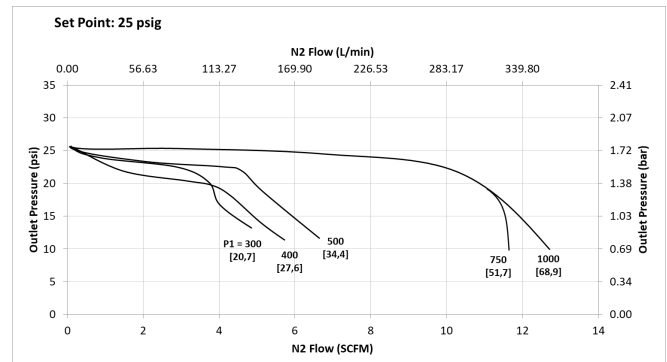
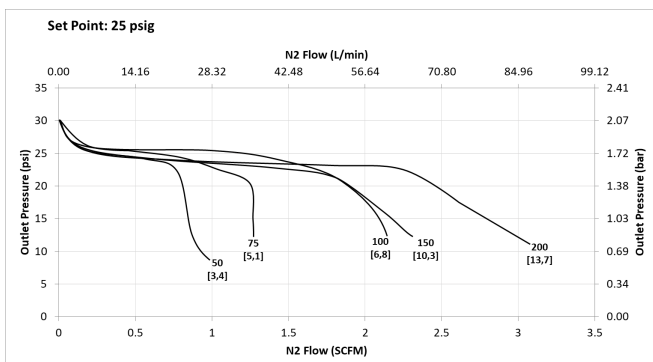
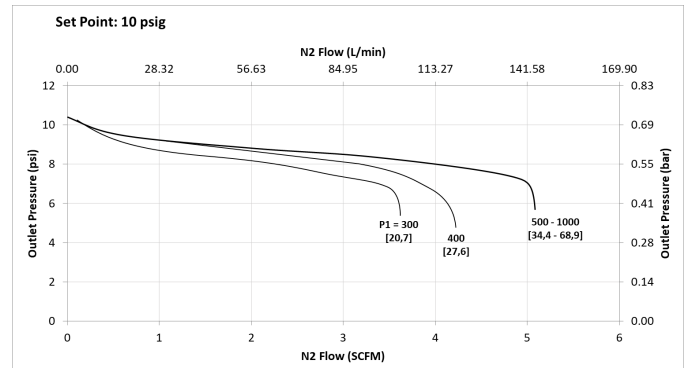
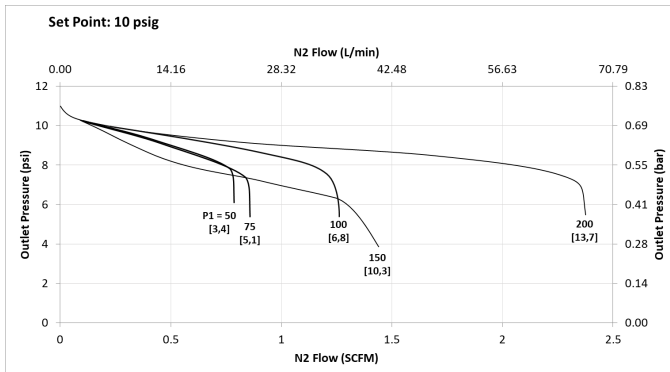
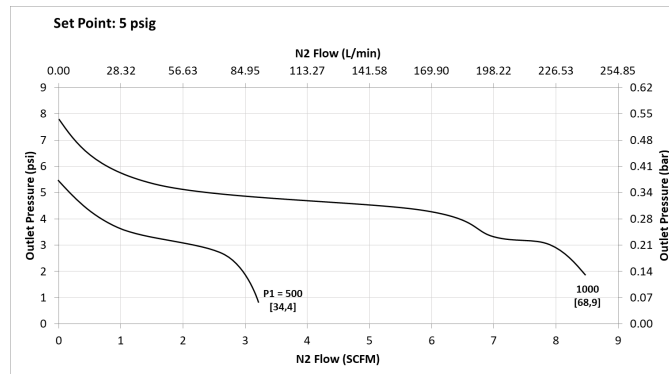

JR SERIES TRIM FLOW GRAPHS

- 0.003Cv – 5 - 50 PSI RANGE

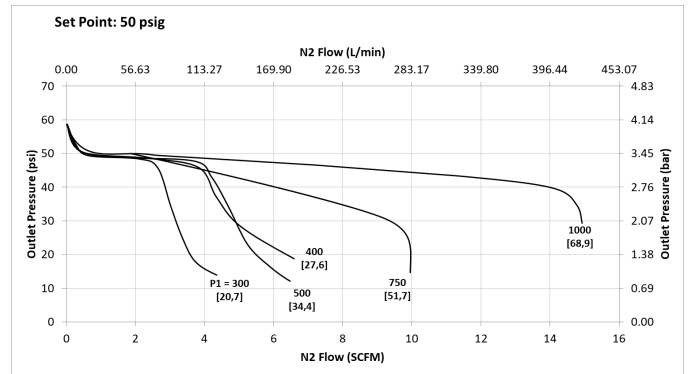
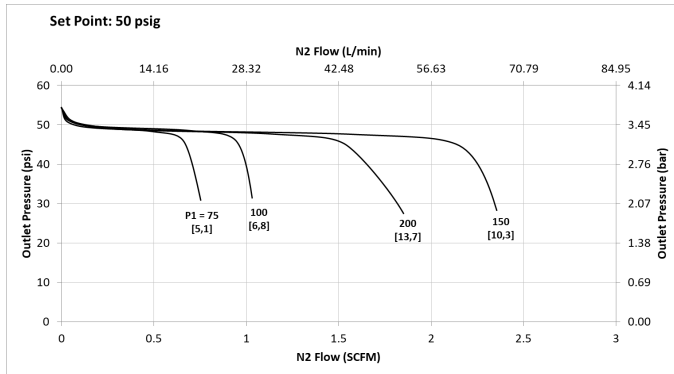

- 0.003Cv – 25 - 100 PSI RANGE

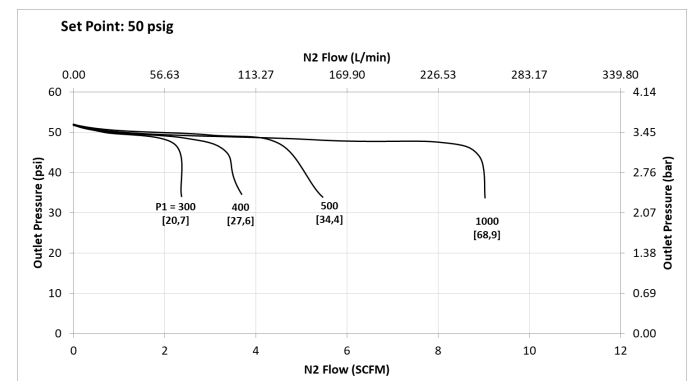
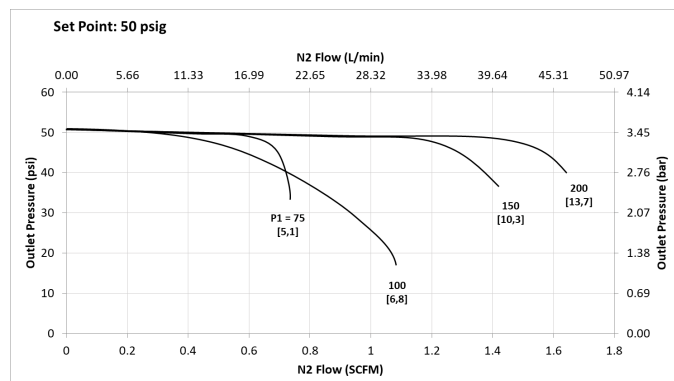
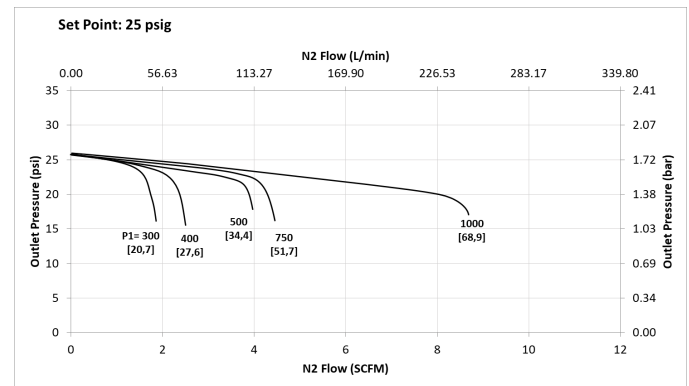
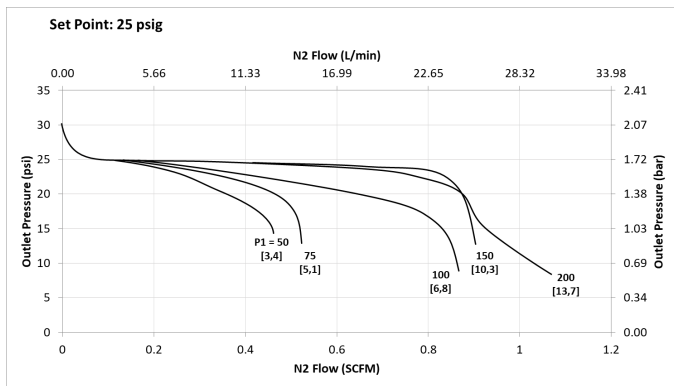

JR SERIES TRIM FLOW GRAPHS

- 0.003Cv – 25 - 100 PSI RANGE

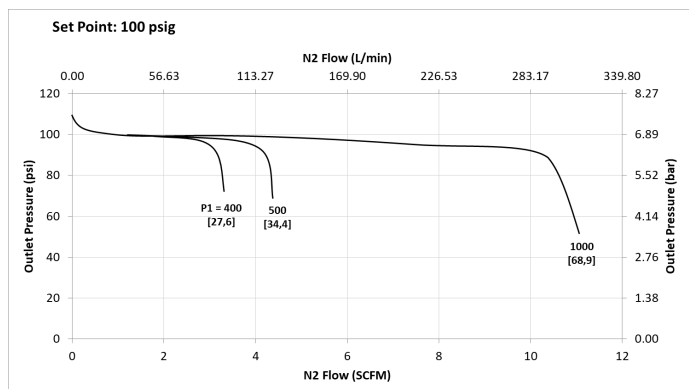
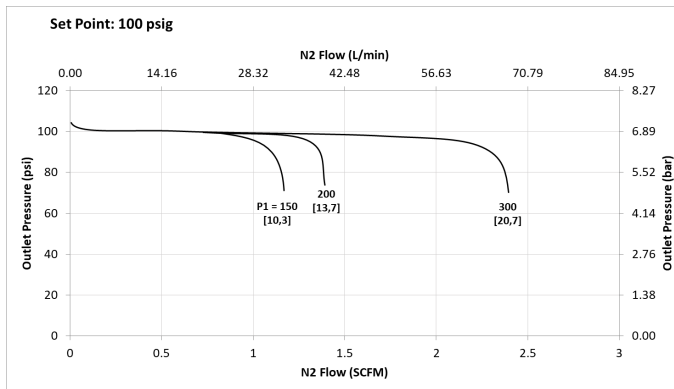
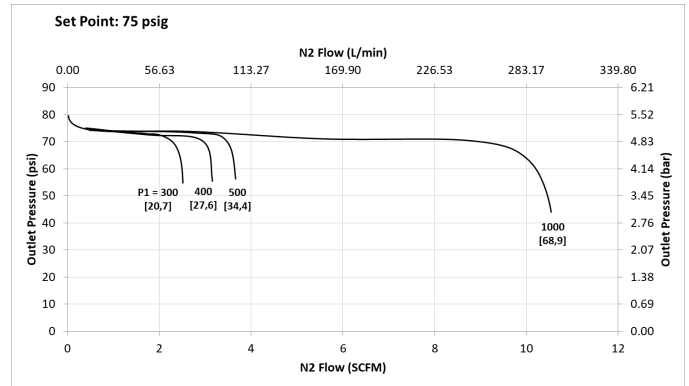
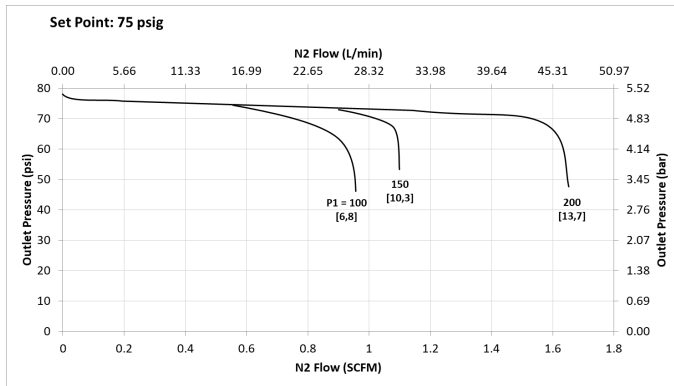

- 0.003Cv – 50- 150 PSI RANGE

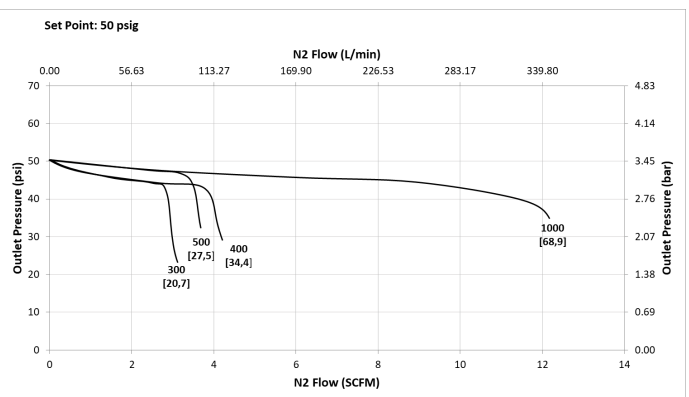
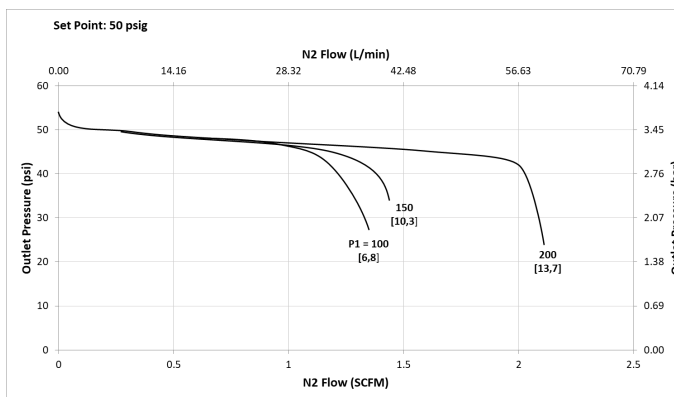

JR SERIES TRIM FLOW GRAPHS

- 0.003Cv – 50 - 150 PSI RANGE

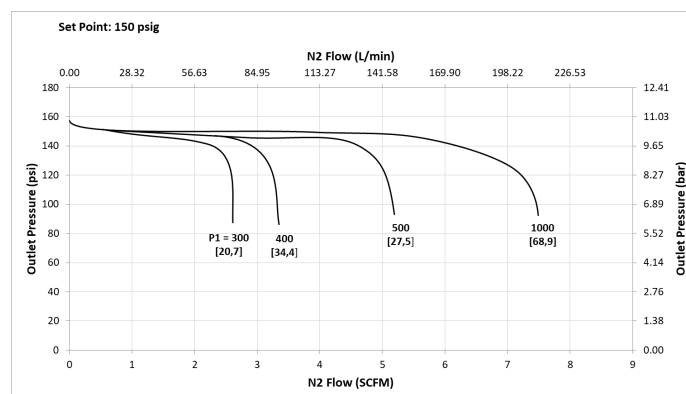
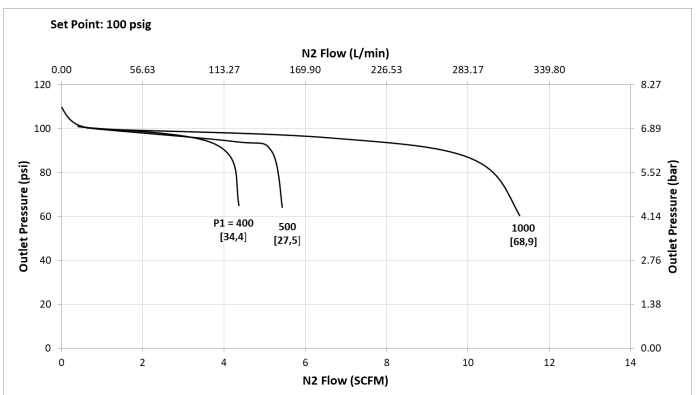
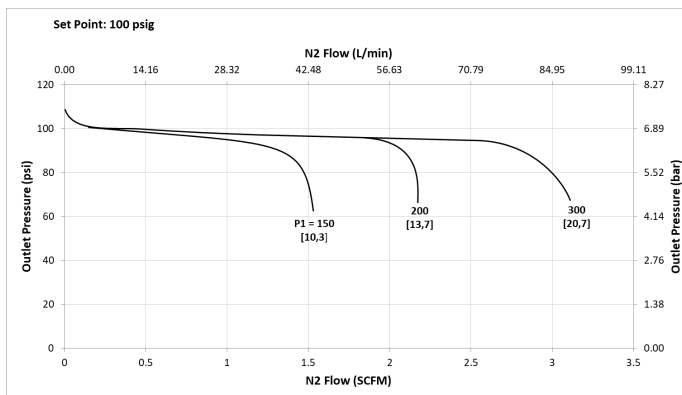
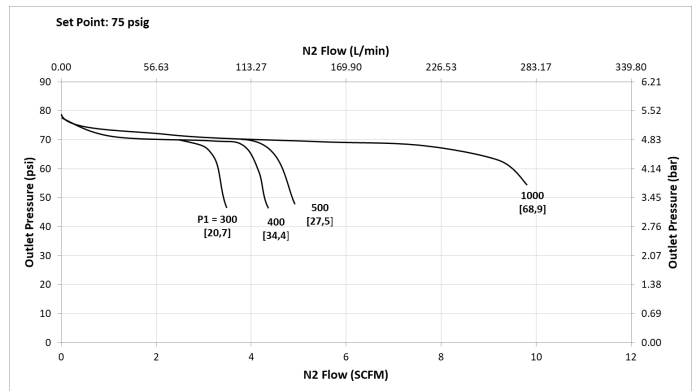
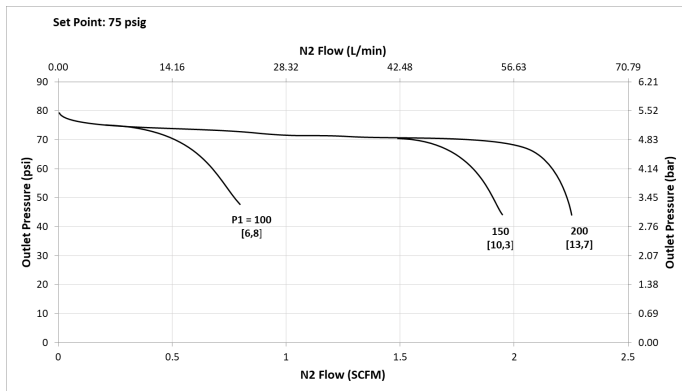

JR SERIES TRIM FLOW GRAPHS

- 0.003Cv – 75 - 250 PSI RANGE

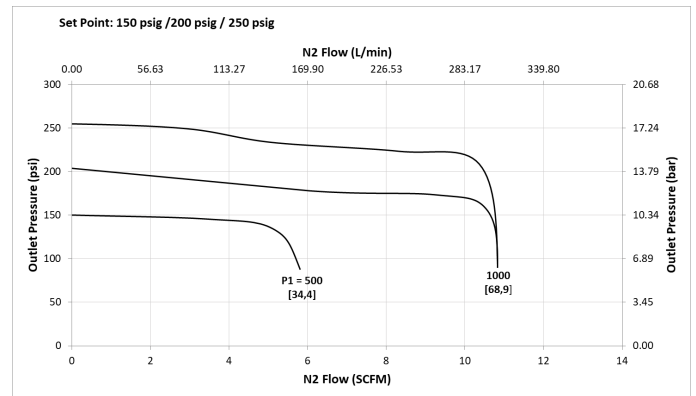
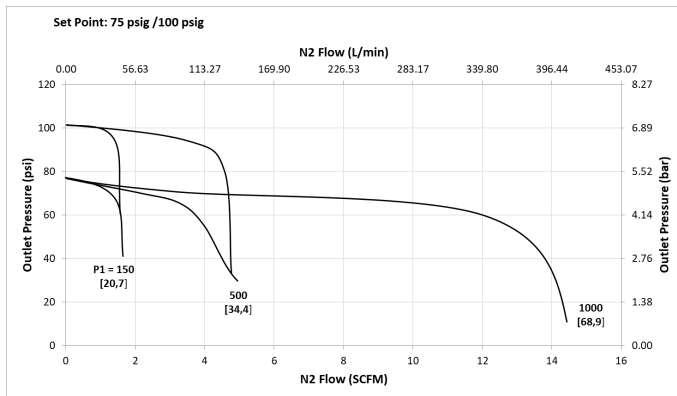

- 0.003Cv – 100 - 475 PSI RANGE

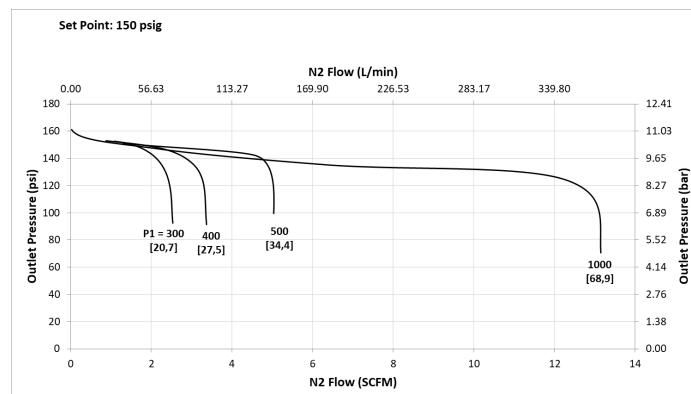
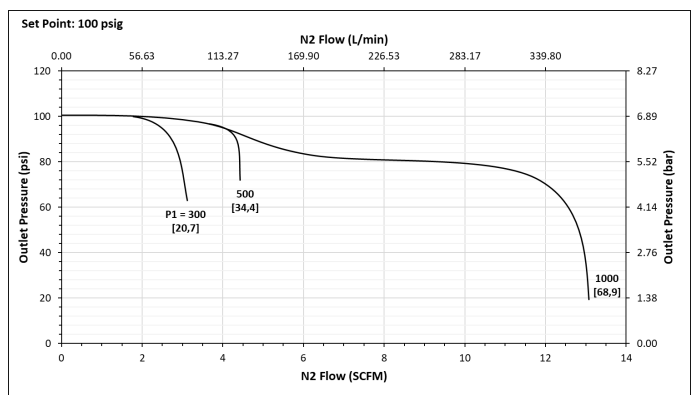
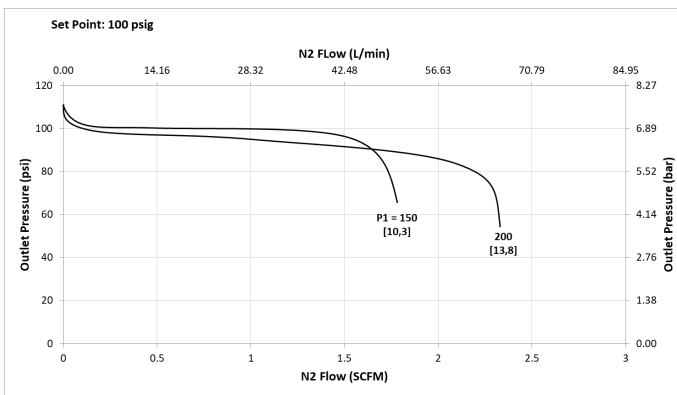

JR SERIES TRIM FLOW GRAPHS

- 0.003Cv – 100 - 475 PSI RANGE

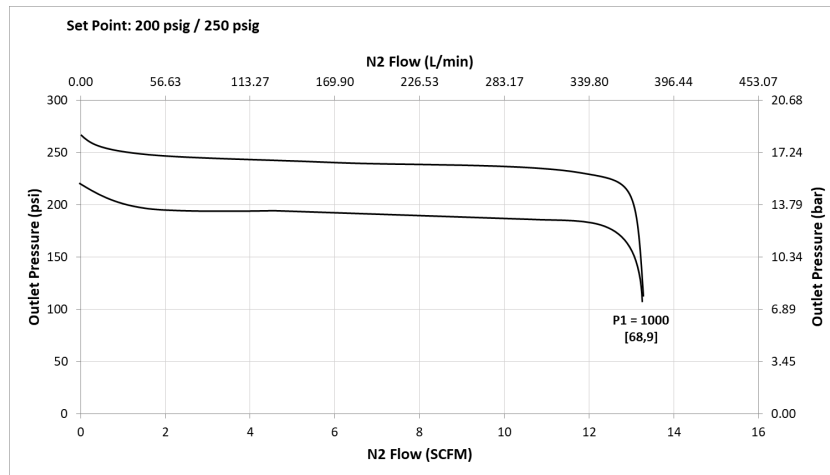

- 0.003Cv – 200 - 750 PSI RANGE

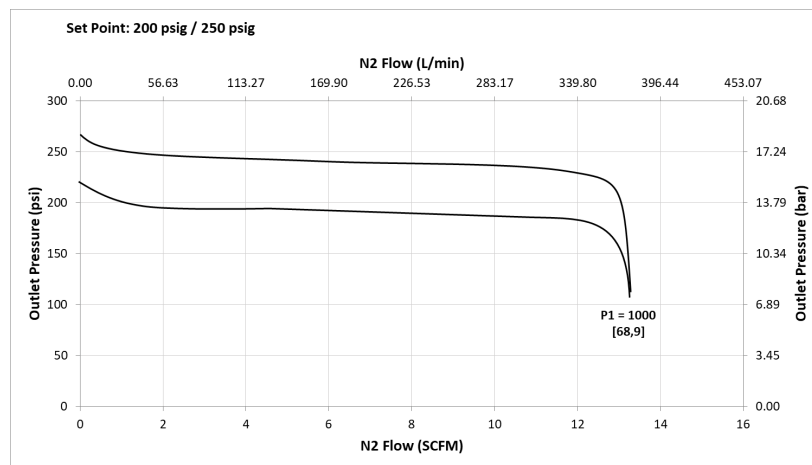

JR SERIES TRIM FLOW GRAPHS

• 0.08Cv – 5 - 50 PSI RANGE

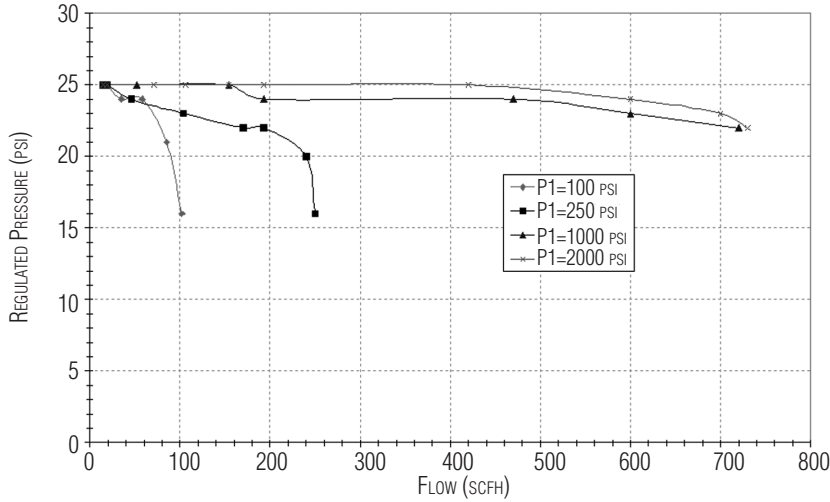

• 0.08Cv – 50 - 150 PSI RANGE

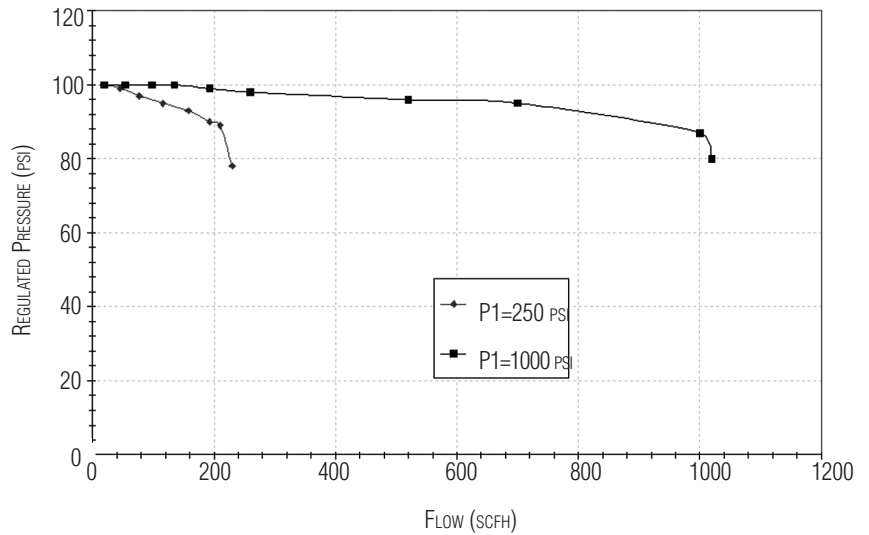

• 0.08Cv – 100 - 475 PSI RANGE

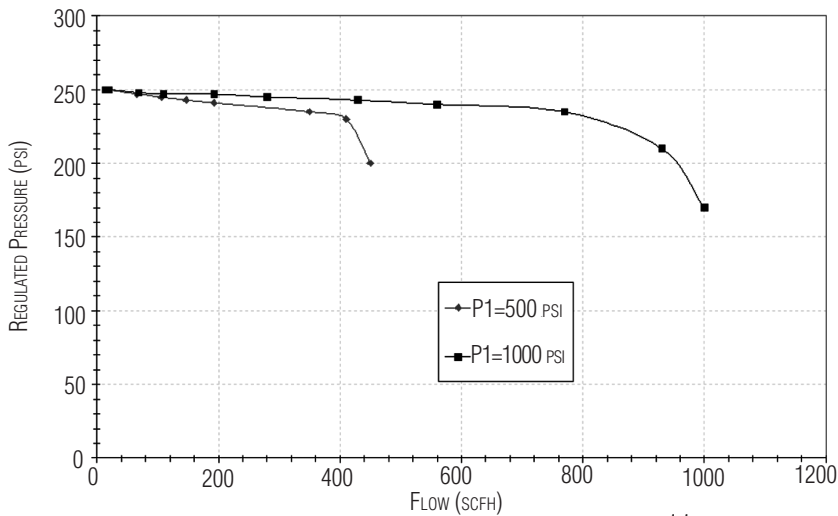

JR SERIES TRIM FLOW GRAPHS

- JR = 0.2 Cv – 5 - 50 PSI RANGE

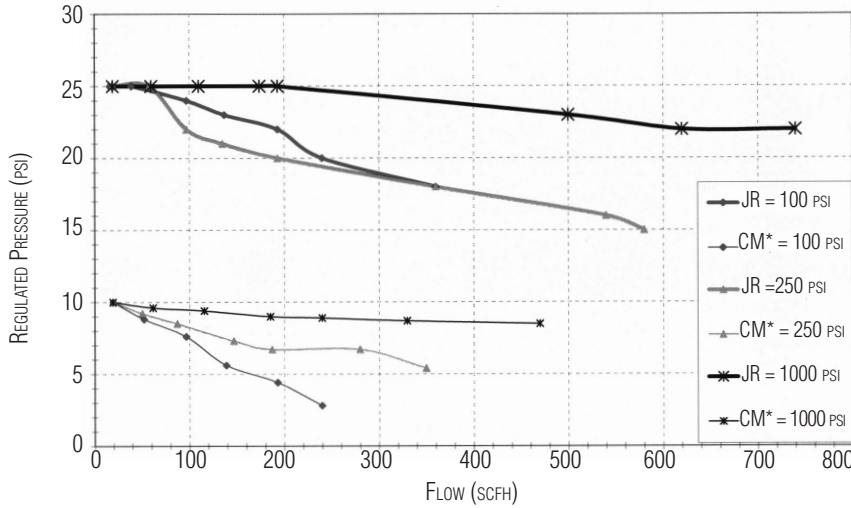

CM* = COMPETITIVE MODEL

- JR = 0.2 Cv – 50 - 150 PSI RANGE

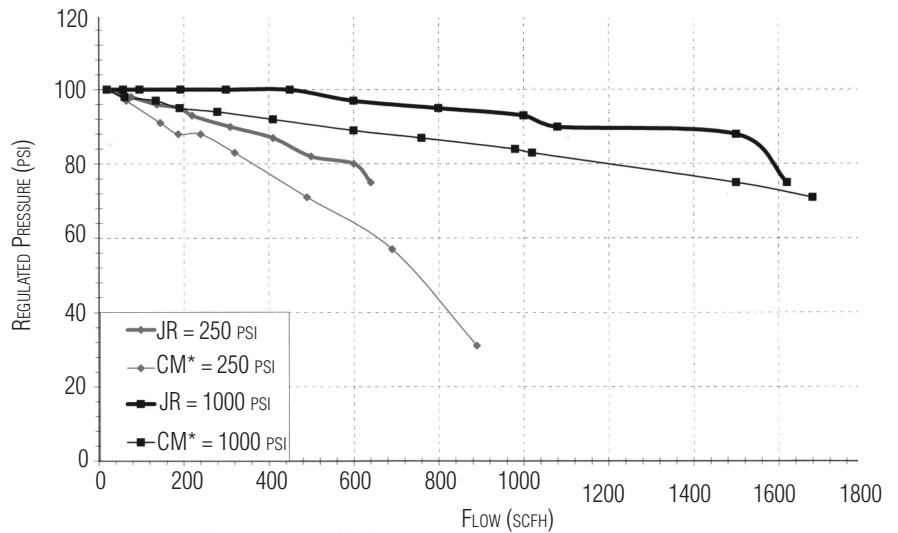

CM* = COMPETITIVE MODEL

- 0.2 Cv – 100 - 475 PSI RANGE

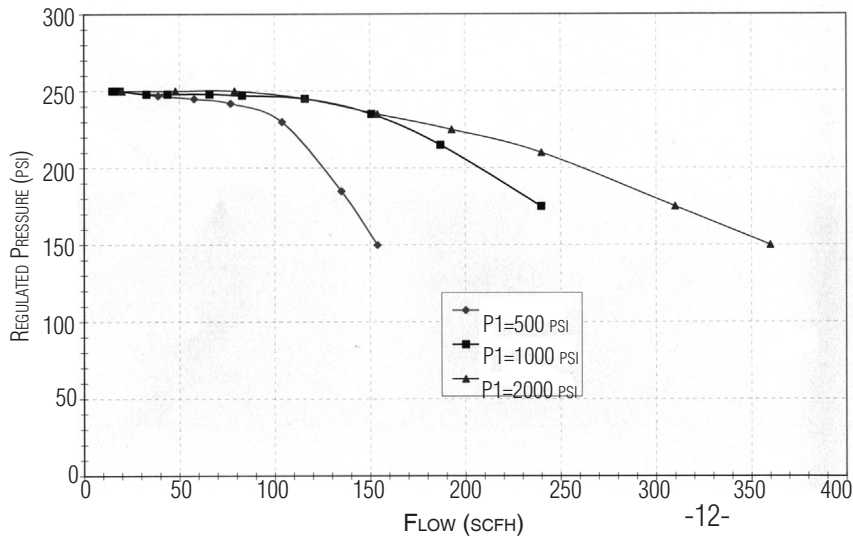

JR SERIES DIMENSIONS

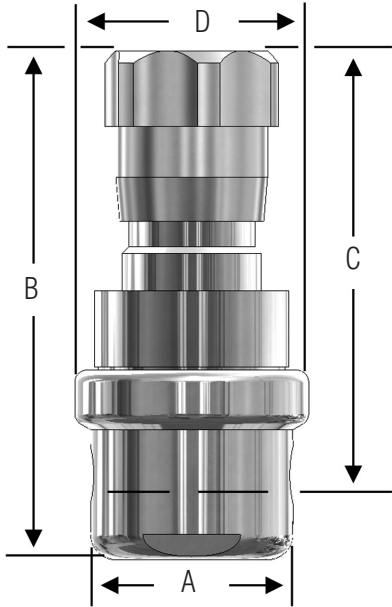

• **JR Series, Inches**

VALVE SIZE	DIMENSIONS, INCHES				WEIGHT, LBS
	A	B	C	D	
1/4"	2.00	5.03	4.20	2.31	3.4
3/8"	2.00	5.03	4.20	2.31	3.4
1/2"	2.75	5.03	4.20	2.31	4.2

• **JR Series, Metric**

VALVE SIZE	DIMENSIONS, MM				WEIGHT, KGS
	A	B	C	D	
DN8	50,8	128	107	58,7	1,5
DN10	50,8	128	107	58,7	1,5
DN15	69,9	128	107	58,7	1,9

JR SERIES FLOW CONFIGURATIONS

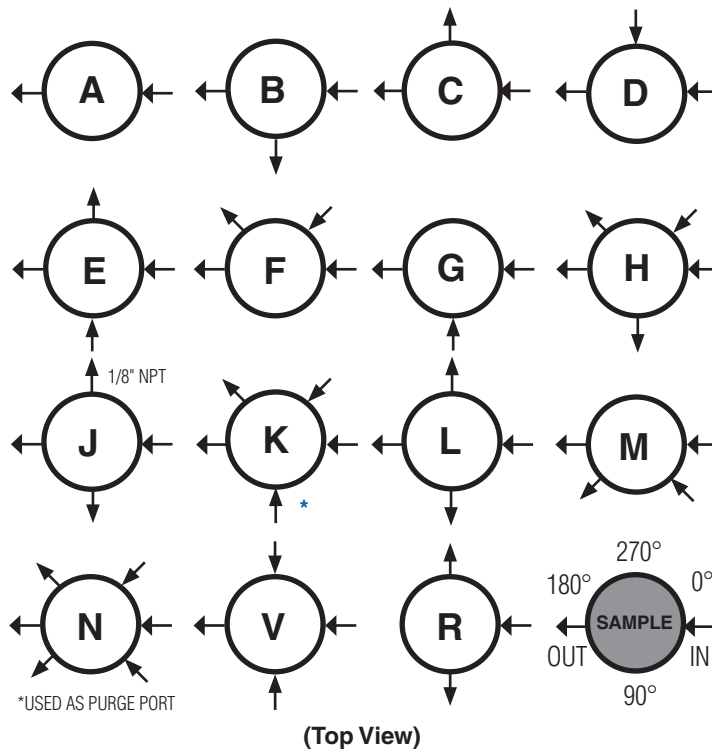

JR SERIES ORDERING SCHEMATIC

Model	Size	Material	1 & 2	3 & 4	5 & 6	7 & 8	9 & 10	11 & 12	13 & 14	15	16	17
—	—	—	/									

Model	
JR	Pressure Reducing Valve

Size	
025	1/4"
038	3/8"
050	1/2"

Material	
6L	Stainless Steel 316L

1 & 2	Body Feature	
End Connection	Port Configuration	
A	FNPT 1/4"	A Port "A"
B	FNPT 3/8"	B Port "B"
C	FNPT 1/2"	C Port "C"
		D Port "D"
		E Port "E"
		F Port "F"
		G Port "G"
		H Port "H"
		J Port "J"
		K Port "K"
		L Port "L"
		M Port "M"
		N Port "N"
		V Port "V"
		R Port "R"
ZZ	Non-Standard	

3 & 4	Trim
1S	Cv 0.012
2S	Cv 0.08
3S	Cv 0.2
4S	Cv 0.03
1R	Cv 0.012 Self-Relieving PTFE
2R	Cv 0.08 Self-Relieving PTFE
3R	Cv 0.2 Self-Relieving PTFE
4R	Cv 0.03 Self-Relieving PTFE
ZZ	Non-Standard

5 & 6	Seat	
Seat Material		Cv
T	PTFE	1 0.012
P	PEEK	2 0.08
K	KEL-F	3 0.2
		4 0.03
ZZ	Non-Standard	

7 & 8	Range Spring/Outlet Pressure
E1	5- 50 psi
E2	25 - 100 psi
E3	50 - 150 psi
E4	75 - 250 psi
E5	100 - 475 psi
E6	200 - 750 psi
ZZ	Non-Standard

9 & 10	Diaphragm Material
JL	Jorlon
ZZ	Non-Standard

11 & 12	Actuator
	Ranges E1 thru E6
SK	Standard
CV	Captured Vent
PM	Panel Mount
TP	Tamper Proof
ZZ	Non-Standard

13 & 14	Inlet Gauge
AA	0 - 30 psig
BB	0 - 60 psig/bar (dual)
CC	0 - 100 psig/bar (dual)
DD	0 - 160 psig/bar (dual)
EE	0 - 200 psig/bar (dual)
FF	0 - 300 psig/bar (dual)
GG	0 - 400 psig/bar (dual)
HH	0 - 600 psig/bar (dual)
JJ	0 - 1000 psi/bar (dual)
KK	0 - 2000 psi/bar (dual)
LL	0 - 3000 psi/bar (dual)
MM	0 - 5000 psi/bar (dual)
NN	None
ZZ	Non-Standard

* Customer assumes all responsibility for possible damage or injury if selected gauge span does not fully cover range spring / outlet pressure option

JR SERIES ORDERING SCHEMATIC

Model	Size	Material	1 & 2	3 & 4	5 & 6	7 & 8	9 & 10	11 & 12	13 & 14	15	16	17
	—	—	/									

15	Outlet Gauge
A	0 - 30 psig
B	0 - 60 psig/bar (dual)
C	0 - 100 psig/bar (dual)
D	0 - 160 psig/bar (dual)
E	0 - 200 psig/bar (dual)
F	0 - 300 psig/bar (dual)
G	0 - 400 psig/bar (dual)
H	0 - 600 psig/bar (dual)
J	0 - 1000 psi/bar (dual)
N	None
ZZ	Non-Standard

* Customer assumes all responsibility for possible damage or injury if selected gauge span does not fully cover range spring / outlet pressure option

16	SEP Compliance
0	None
G	SEP Compliant
Z	Non-Standard

17	Accessories
0	None
S	Clean for Oil Free*
X	Clean for Oxygen*
Z	Non-Standard

*Consult factory for compatible gauge options